

LI-6400XT System

Photosynthesis, Fluorescence, Respiration



LI-COR[®]

LI-6400XT - The Innovation Continues

The LI-6400XT is LI-COR's newest photosynthesis system, which embodies all of the qualities that made the earlier generations a success: portability, ruggedness, flexibility, and a high level of hardware and software integration.

These early generations of photosynthesis systems include the LI-6000, released by LI-COR more than 25 years ago. The LI-6200 followed three years later, incorporating LI-COR's own gas analyzer design. The LI-6400 was next in line, and quickly became the world leader in portable photosynthesis measurement systems.

But you don't have to take our word for it – review the literature to see why the LI-6400/LI-6400XT is the most referenced photosynthesis system in scientific publications, talk to other scientists who have used one, or talk to one of our knowledgeable Application Scientists to see for yourself why the LI-6400XT is the undisputed market leader.

Read further to learn some of the reasons the LI-6400XT is the choice of scientists around the world, including:

- Proven technology that places the gas analyzers in the sensor head, to provide rapid response and eliminate time delays.
- An open system design that allows complete control over environmental variables of interest.
- A flexible, open source software language in the LI-6400XT console that can be modified to write your own equations or AutoPrograms, providing an unprecedented level of automation.
- Powerful networking capability via Ethernet connectivity, providing a world of data output, file-sharing, and training possibilities.
- A variety of leaf chambers and light sources, a leaf chamber fluorometer, and soil CO₂ flux chamber that are interchangeable with the same LI-6400XT sensor head.
- Worldwide service, support, and training that ensures your purchase of the LI-6400XT remains a smart investment for years to come.

Photosynthesis

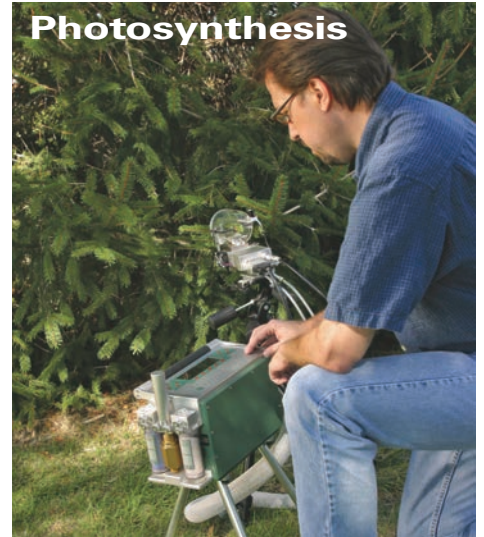

Fluorescence

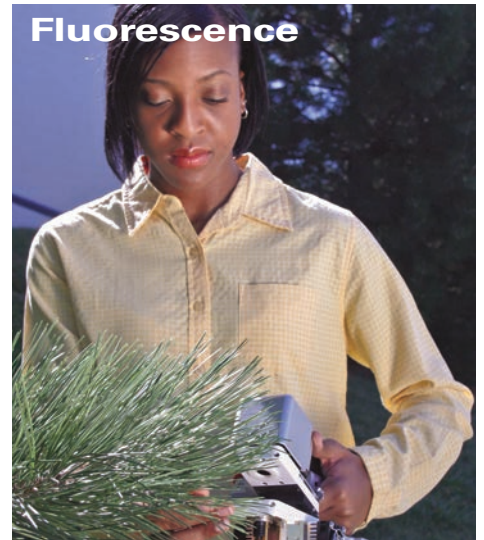

Respiration



Proven Technology

Analyzers in the Sensor Head

The LI-6400XT has two absolute CO₂ and two absolute H₂O non-dispersive infrared analyzers in the sensor head. Mounting the analyzers in the sensor head provides a number of advantages over systems which place the analyzers in the console:

1. Changes in the leaf dynamics are measured in real time. Because there is no tubing between the leaf chamber and the console, there are no time delays confounding effects of changes in environmental driving variables such as light, CO₂ mole fraction, etc.
2. CO₂ and H₂O concentrations are controlled at the leaf surface, because the fast response IRGAs are built into the mixing volume of the leaf curvette. This is important because, for example, it allows you to easily make photosynthesis comparisons across treatments with widely differing rates, at a constant CO₂ concentration, thus avoiding biases in your conclusions.
3. CO₂ and H₂O concentrations are continuously measured at both reference and sample cells, eliminating flow swapping, which provides fast response times, minimizes noise and drift, and gives more accurate photosynthesis measurements.
4. Rapid, automatic control of chamber humidity is possible, even when the transpiration rate is changing.
5. Absence of tubing between the chamber and the analyzers eliminates equilibration times due to water vapor sorption on the tubing walls.

Analyzer Operation

Infrared radiation from the sample analyzer source passes into the leaf chamber mixing volume and is twice reflected 90° by gold mirrors. The mirrors are gold plated to enhance IR reflection and provide long-term stability.

After being reflected through the leaf chamber mixing volume where IR absorption occurs, infrared radiation passes through a chopping filter wheel and into the sample analyzer detector.

The chopping filter wheel has four filters that pass light in absorption and optical reference wavelengths for CO₂ and H₂O. These filters provide excellent rejection of IR radiation outside the wavelengths of interest, eliminating the effects of other IR absorbing gases.

The reference analyzer measures incoming gas concentrations and is located directly below the sample analyzer. The sample and reference analyzers can be matched at any time, either manually or automatically, without altering conditions in the leaf chamber.

The sample analyzer detector, reference analyzer detector, and chopping filter wheel are sealed in a housing that is continuously purged of CO₂ and water vapor to prevent interference.

Through years of experience, the LI-6400XT analyzer and sensor head have proven to be robust and reliable, even in the most rigorous field conditions.



LI-6400XT Console

The LI-6400XT system console combines a data acquisition system with a high-speed computer for dedicated data logging and computations. High speed analog-to-digital converters support fast response applications.

The backlit 8 x 40-character graphical display allows any 12 experimental variables to be displayed at once. All computed variables are calculated and displayed in real time. The full keyboard is membrane sealed and designed to be used under harsh field conditions.



Powering the LI-6400XT

The LI-6400XT system is powered by 12VDC batteries stored in the console. Four batteries and a battery charger are included with the system, providing 4-8 hours of operation. The optional 6400-70 AC Adapter fits in one of the battery compartments.

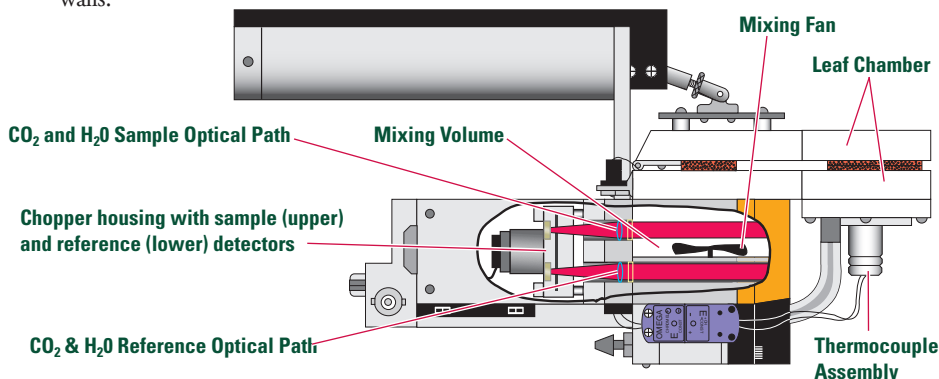

Controlling the Environment

The LI-6400XT open system design allows automatic, independent control of leaf chamber CO_2 , H_2O , temperature, and light.

CO_2 Control (optional)

The 6400-01 CO_2 Injector System consists of an electronic controller, a CO_2 Source Assembly that uses readily-available cartridges for portable operation, and a CO_2 tank fitting for greenhouse or laboratory operation. All parts integrate directly into the standard console with no external batteries or control modules.

The CO_2 Injector System provides a constant CO_2 input from 50 to 2000 $\mu\text{mol mol}^{-1}$. CO_2 is controlled by delivering a precisely controlled pure CO_2 stream into air that is CO_2 -free. The CO_2 concentration can be controlled at the incoming air stream or at the leaf surface to within 1 ppm of a target value.

The 6400-01 facilitates measurements at elevated CO_2 concentrations and easy generation of CO_2 response curves. The CO_2 injector is under complete software control, allowing you to manually set CO_2 levels from



the console, or use AutoPrograms to make measurements at a series of concentrations.

12g cartridges provide up to 8 hours of operation. The cartridges are accessible outside the instrument, making them easy to change.

H_2O Control

The LI-6400XT controls chamber humidity by automatically varying the flow rate to null-balance at the chamber humidity level you specify in software; the input flow rate can also be held constant. Flow rate is controlled by pump speed in the standard system. With the 6400-01 CO_2 Injector System, pump speed is constant and flow rate to the chamber is controlled by redirecting excess flow. This “shunt regulation” allows flow to be controlled smoothly and quickly across a broad range.

Whether the controller in the 6400-01 is used or not, air supplied to the chamber may be dry or moist. Supplying the chamber with moist air allows higher flow rates to be used to balance low transpiration rates, which provides more stable control and more accurate measurements. Inaccuracies and time delays due to water sorption on the air lines between the console and the sensor head are eliminated by measuring the reference and sample water vapor concentrations in the sensor head.

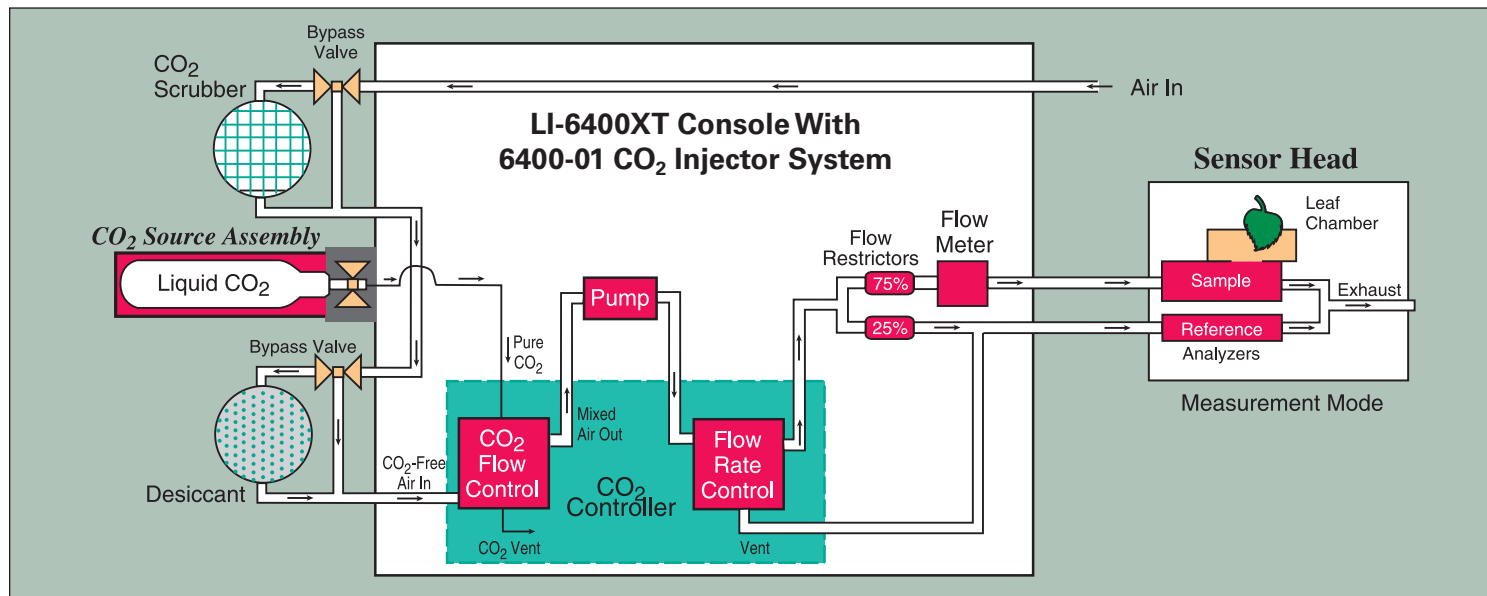

Temperature Control

Integrated Peltier coolers control temperature based on either leaf temperature or chamber block temperature (software selectable). Chamber block temperature can be set to any value within $\pm 6^\circ\text{C}$ of ambient temperature. Temperature control is a standard feature of the LI-6400XT; no bulky external power supplies or accessories are required. An optional Expanded Temperature Control Kit is available (p/n 6400-88) that can increase the range of temperature control of the sensor head block.

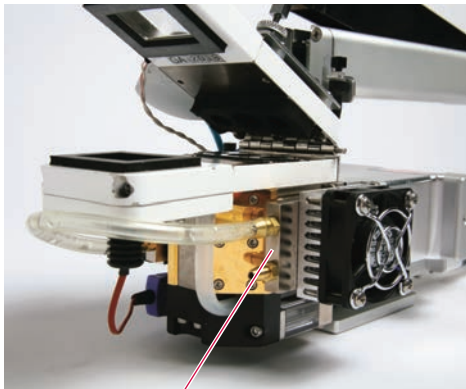

6400-88 Water Jacket

Light Control

The 6400-02B LED Light Source, 6400-18A RGB (Red, Green, Blue) Light Source, and 6400-40 Leaf Chamber Fluorometer (all optional accessories) are integrated with the hardware and software of the LI-6400XT System.

The use of LEDs makes them practical light sources because of their small size and low power consumption. LEDs also minimize the influence of the light source on the leaf temperature and are easily computer controlled.

Light Source and Fluorometer light output is continuously variable over the entire measurement range, so you can specify any light level without needing to make adjustments or change filters. Light curves can be generated automatically using AutoPrograms and user-selectable light set points.

The Light Sources are easily installed in the field. Careful placement of the LEDs also ensures uniform light distribution at the leaf surface.

Accuracy during operation is assured by a feedback photodiode that adjusts the light source to maintain the target value.



The 6400-02B Red/Blue LED Light Source.



The 6400-18A RGB Light Source.

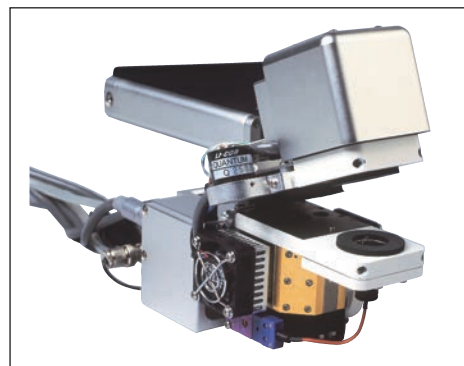

The 6400-40 Leaf Chamber Fluorometer.



The 6400-18A RGB Light Source is designed to be used with the 6400-17 Whole Plant Arabidopsis Chamber; the package is available under part number 6400-17L.

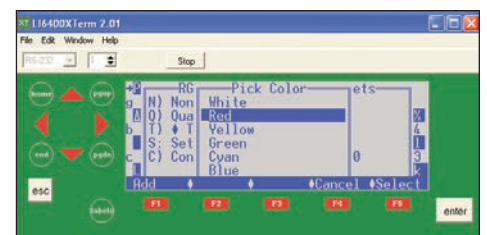

Using the 6400-18A, you can choose from a variety of colors, or define your own custom blended color.

Data Output and Networking



When you're ready to output your data, the LI-6400XT provides a variety of output options to suit your particular needs. Use the standard 9-pin RS-232 port on the console to connect to your computer and output real-time or logged data. If you're away from your computer, simply log your data to the removeable Compact Flash card, and transfer the files without moving the instrument. Compact Flash cards also make it easy to transfer files to other LI-6400XTs.

To skip the file transfer process completely and open data files directly on the computer, your instrument can be connected to an existing Local Area Network (LAN), making the LI-6400XT a powerful networkable device. No special configuration is needed; plug the Ethernet adapter card into the expansion slot on the back of the instrument case, plug the other end into your computer or LAN, and you're ready to share files across your network.



Ethernet connectivity

Ethernet connectivity is a powerful tool for performing various networking operations, including:

1. Dragging and dropping files between instruments, computers, or networked printers.
2. Configuring multiple LI-6400XTs in the same way by moving configuration files.

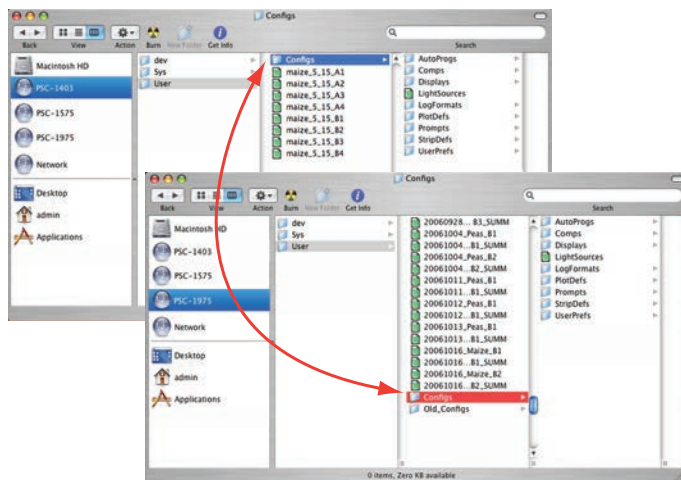

3. Connecting multiple clients simultaneously to a single LI-6400XT.
4. Controlling the instrument remotely.
5. Displaying a simulated keyboard so training participants can "see" the keys being pressed on the client keyboard.

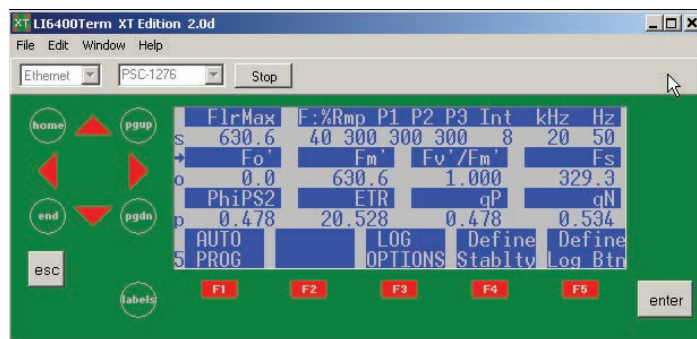

After connection, the display will show exactly what's on the instrument's display. The buttons around the simulated display behave the same as those on the instrument.

6. Opening chat windows between connected clients so that a technician, for example, can be using the LI-6400XT while a supervisor watches from a remote location.

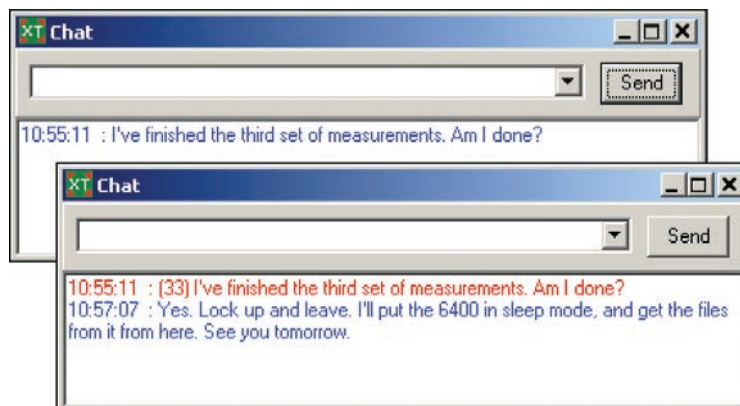

7. Connecting to file transfer applications for direct uploading or downloading of files.

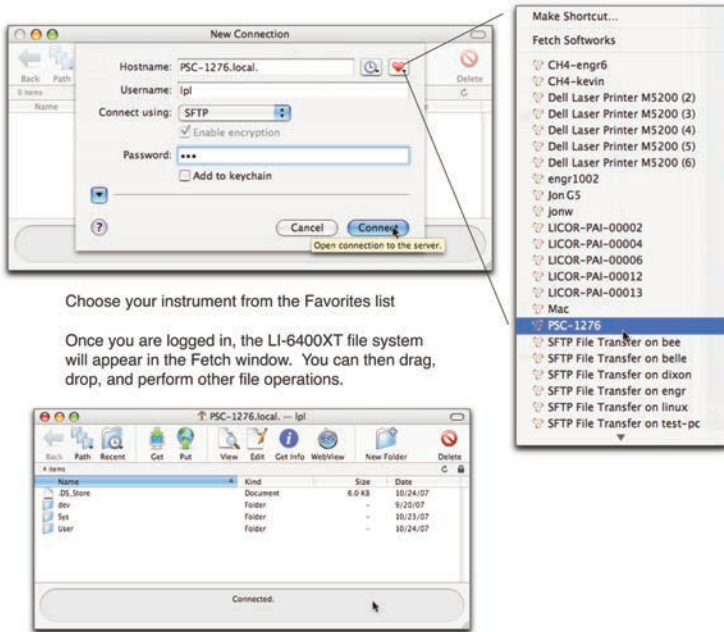

8. Using command line operations to perform automatic daily backups of the data on your LI-6400XT, or synchronize folders on the instrument and your computer.

The LI-6400XT supports a wide variety of networking protocols for Windows, Macintosh, Linux, and Unix networks, including Secure Shell (SSH), SSH File Transfer Protocol (SFTP), Samba, and Zero Configuration Networking.

Create Excel Files with Embedded Equations

For the ultimate in data processing simplicity, your LI-6400XT data files can be generated in native Excel format with equations embedded, in parallel with the files created by the LI-6400XT. This allows you to easily recompute files should you need to make a change to leaf area, boundary layer, or other inputs.

Obs	HMMSS	FTime	EBal?	Photo	Cond	Ci	Trmmol	VpdL	CLeaf	Area	BLC_1	StmRat	BLC
11	10:06:44	34.5	0	8.5573313	0.08353593	220.294214	1.40379188	1.63449871	23.7025719	2	2.29826099	1	4.5
12	2:10:06:54	45	0	8.33701214	0.08358411	220.804777	1.41615554	1.64776782	23.79802996	2	2.29826099	1	4.5

When we change the leaf area of the first observation, the computed numbers change automatically.

Bar Code Reader Support

When making high volume survey type measurements, the RS-232 port can be used to enter remarks and constants from devices such as bar code readers. When prompted for a remark or constant (e.g. leaf area), simply point the bar code reader and press its button to enter the coded data into the LI-6400XT file.



OPEN 6.0
Tue Feb 10 2009 09:49:28
Unit= PSC-1529
ComputeList= /User/Configs/Comps/Default
BLCTable= /Sys/Lib/StdBLCTable
LightSource= 6400-02B 1 0.25
LogFormat= /User/Configs/LogFormats/Std Output survey
LogCodes= -35 -21 -36 -107
PromptList= /User/Configs/Prompts/survey
Stability= (CO2s 15s SLP<1)(H2OS 15s SLP<1)(Flow 15s SLP<1)

9:49:30

\$\$STARTOFDATA\$

Obs	HMMSS	FTime	Remarks	Photo	Cond	Ci
1	9:55:41	375	Pot1 Row1	7.98	0.0474	11
2	9:59:43	617	Pot2 Row1	7.68	0.0449	107
3	10:02:07	671	Pot3 Row1	8.06	0.0397	55.9
4	10:03:50	864	Pot4 Row1	8.24	0.0372	25.7
5	10:06:41	1035	Pot5 Row1	8.09	0.0768	210
6	10:08:56	16915	Pot6 Row1	6.73	0.0291	13
7	10:11:49	1343	Pot1 Row2	7.5	0.0316	1.63
8	10:15:10	1544	Pot2 Row2	7.06	0.0361	67.7

Flexible Software

OPEN Instrument Software

The software application used by the LI-6400XT to make measurements is called OPEN, due to the source code transparency that allows it to be modified according to each user's unique needs. Programs and data are stored in simple ASCII format, allowing the on-board editor or other external word processors to open existing computation lists, for example, modify them, and save under a new name. Novice users can use the simple software defaults to make measurements using pre-defined AutoPrograms; more experienced users may choose to modify the software using the included Programming Guide to unlock the potential of the open source application.

OPEN uses the console display to show any of the experimental variable in text or graphical modes. This allows you to examine the approach to steady state for any of the variables of interest with as many as 3 plots per graph set.

A variety of built-in AutoPrograms allow you to choose setpoints for desired chamber environmental conditions. After the system stabilizes, data are logged, and the cycle repeats for the next set point. All other environmental controls maintain their setpoints, providing stable conditions for your experiment. AutoPrograms can be modified, stored, or created using your own combination of setpoints and desired environmental conditions.

Simulator Software

The included Simulator software allows you to completely simulate your LI-6400XT on your computer screen. This is a convenient way to write and test your own equations or AutoPrograms, train yourself or others, and manage your data.

Remote Control Capability - Great for Teaching

LI6400XTerm software is also included, which is designed to be used as a terminal program to remotely control the LI-6400XT and display real-time data on your computer, while the LI-6400XT continues to function normally. This can be an invaluable tool for teaching others how to use the LI-6400XT in classroom or seminar presentations; simply implement the terminal program, connect your computer to a projector, and demonstrate to a roomful of students how the LI-6400XT works.

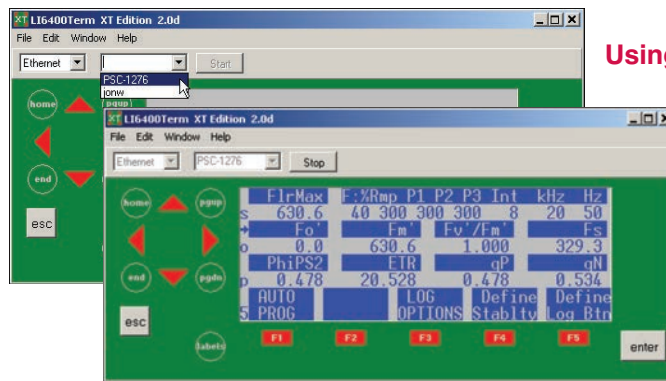

Using LI6400XTerm, you can:

A. Connect to your LI-6400XT via Ethernet or RS-232 to show what is on the instrument display.



B. Display a simulated keyboard so class participants can see what keys are being pressed.

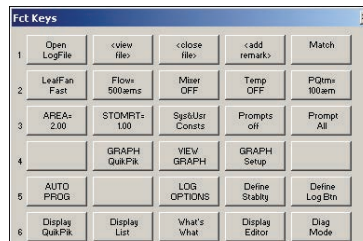

C. Display all available function keys as active buttons.

D. Display a variables monitor window, where you can view any variable, without it having to be on the instrument's display.

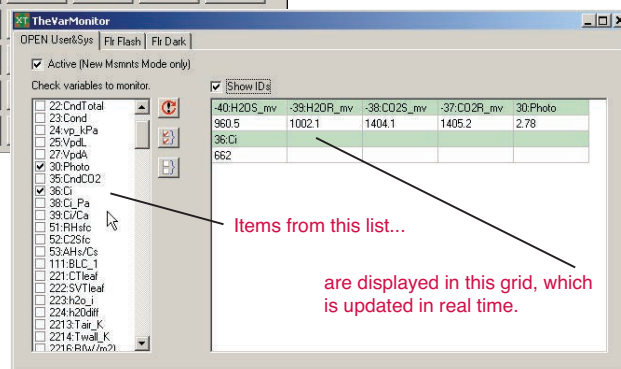

Training, Support, and Educational Resources



Photosynthesis Educational Resource Package

The Photosynthesis Educational Resource Package is designed to help educators incorporate the LI-6400XT Portable Photosynthesis System into the classroom. This package is part of the Learn@LICOR initiative, an effort to provide educators with the tools needed for training students in theory, practical applications, and instrumentation. LI-COR scientists have collaborated with Dr. Jed Sparks, Associate Professor of Ecology and Evolutionary Biology at Cornell University to design a series of lecture topics and experiments that feature the LI-6400/6400XT. The resource package consists of a CD and two DVDs with lecture notes, Powerpoints, and laboratory activities designed around the LI-6400XT. The modules include photosynthesis, leaf respiration, light response, temperature response, CO₂ response, soil respiration, leaf chlorophyll fluorescence, and other topics. For more information go to: www.licor.com/env/PDF/6400-520.pdf.

Training Courses

LI-COR is committed to providing the best support available to you, so that the LI-6400XT remains an excellent investment for years to come. Every LI-6400XT purchase includes a free two-day training course at LI-COR's facility. A third day of training, dedicated to fluorescence measurements, is available for a fee. Trainees will learn how to use the LI-6400XT terminal programs, so they can train others when they return home. Or, if you prefer to learn at your own pace, or simply need a refresher course, LI-COR offers video-based training CDs (6400-512) that contain much of the same material presented at our training courses.



"LI-COR staff were very professional and took pride in making sure we understood the material. Their hospitality is top-notch. There's a reason for your success."

—Paul Jackson, USDA Forest Service

Knowledgeable Support Staff

At LI-COR you will find a group of knowledgeable Applications Scientists available to help answer questions and guide you as you use the LI-6400XT. Using the Ethernet connectivity built into the LI-6400XT, you can even grant LI-COR Scientists access to your instrument, allowing them to review data and diagnose problems worldwide. LI-COR also offers a comprehensive support web site where you can find quick and helpful information including application notes, technical tips, installation instructions, free software downloads, and online instruction manuals.

International Support

LI-COR employs a global network of more than 20 international distributors who provide sales and support to our international customers. In addition, LI-COR has subsidiaries in Germany and the United Kingdom. LI-COR GmbH in Bad Homburg, Germany, provides repair and recalibration services to customers throughout Europe.

Free Software Upgrades

LI-COR is continually adding software features to support new leaf chambers and add functionality to your system to help you get the most out of your investment. Software upgrades are always free, for the life of your LI-6400XT.

Leaf Chambers and Accessories

A variety of interchangeable leaf chambers are available for use with the LI-6400XT. Each chamber is designed for simple operation. Internal surfaces are coated to minimize water sorption, and external surfaces minimize radiation absorbance and maximize emissivity. Replaceable gaskets are nearly impermeable to CO₂ and water vapor, and seal tightly.

Leaf temperatures are measured directly using a thermocouple, or estimated using energy balance in the 6400-05 Conifer, 6400-07 Needle, and 6400-15 Extended Reach 1 cm Chambers.

A bracket is provided on the LI-6400XT sensor head, or on the chamber itself, to hold a LI-COR Quantum Sensor for measuring ambient photosynthetically active radiation (PAR). Other chambers measure PAR in the chamber using a small GaAsP sensor.



Standard 2 x 3 cm Chamber

Coniferous Plants



6400-05 Conifer Chamber

Features a 7.5 cm diameter that accommodates short-needled conifers with needles up to 3.5 cm long. The 6400-05 replaces the typical upper and lower leaf chambers, and mounts directly to the sample cell of the CO₂ and H₂O IRGAs. The Conifer Chamber is constructed of acrylic for durability and lined with teflon to minimize water sorption.



6400-07 Needle Chamber

For measuring long-needled conifers, specially designed foam pads hold up to 5 needles in the 2 x 6 cm chamber. The 6400-07 allows each needle to be pressed into place in the chamber, where it is held securely in the channels of the foam mounting pad. The 6400-07 top and bottom have clear windows for excellent light transmittance. A quantum sensor in the chamber provides light measurement at the plane of the needles.

Broadleaf Plants

The standard leaf chamber included with the LI-6400XT is suitable for a variety of deciduous leaf sizes, has a 2 x 3 cm clear top, and an opaque bottom.



6400-08 Clear Chamber Bottom

Illuminating the bottom of a leaf is useful for survey measurements and erect foliage. The Clear Chamber Bottom has a Propafilm® window similar to the standard chamber top. The Clear Chamber Bottom is designed to be used with any 2 x 3 cm chamber top.



6400-11 Narrow Leaf Chamber

Ideal for foliage with narrow bladed leaves, the 6400-11 has a 2 x 6 cm aperture, and measures PAR inside the chamber at the leaf plane.

Specialized Applications

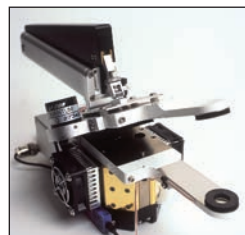

6400-15 Extended Reach 1 cm Chamber

The 6400-15 Extended Reach 1 cm Chamber was designed for measurement of small leaves of rosette plants, which are difficult to clamp with conventional chambers. The 6400-15 has clear apertures for natural illumination of the top and bottom of the leaf. The aperture is 1.0 cm in diameter and is positioned 8.5 cm away from the main body of the IRGA. This chamber is designed to be used with CO₂ concentrations near ambient.



6400-17 Whole Plant Arabidopsis Chamber

The 6400-17 provides a much larger aperture (7 cm diameter) for measurements of entire Arabidopsis rosettes, rather than just the leaves.

Chamber air temperature is measured by a thermocouple in the air return path, preventing radiant effects from the light source. This thermocouple plugs into the existing thermocouple block on the LI-6400/6400XT sensor head.

The leaf temperature is computed in software using an energy balance approximation. An O-ring sealed top plate with a Propafilm covering is placed over the chamber when making measurements. The O-ring provides a tight seal that eliminates the need for traditional foam gaskets.

Because soils or artificial media are present within the chamber volume, CO₂ fluxes from the soil can be introduced into the whole plant measurement. A standard peat media mix capped with a heavy clay layer on top suppresses soil respiration. An exhaust tube fitting is also provided that can be used to apply a slight over-pressure within the chamber, which also suppresses CO₂ fluxes from the soil.



Interchangeable chamber bottom plates are provided for use with readily available 2.5 in. (65 mm) pots or 1.5 in. (38 mm) Cone-tainers.

Soil CO₂ Flux Measurements



6400-09 Soil CO₂ Flux Chamber

The LI-6400XT and 6400-09 address the many challenges of making soil CO₂ flux measurements in a variety of ways, including:

- The chamber concentration is automatically scrubbed to just below an ambient target, and then measured as it rises to slightly above ambient. This maintains the CO₂ concentration gradient to within a few ppm of the natural, undisturbed value. The flux is computed according to the rate

of change of CO₂ concentration with time. Automated cycling ensures that CO₂ flux measurements are accurate and repeatable.

- A pressure equilibration tube is used to eliminate pressure differentials and avoid chamber leaks.
- Air inside the 6400-09 is thoroughly mixed while maintaining a constant pressure; this, along with a water vapor dilution correction, results in consistently accurate data.

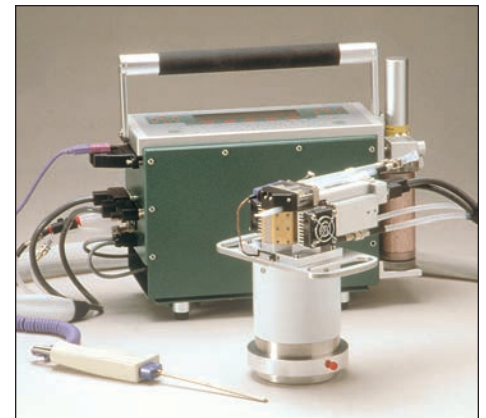

Calibration of H₂O Gas Analyzers



LI-610 Portable Dew Point Generator

The LI-610 is a rugged, portable instrument that provides a stream of gas with a precisely controlled dew point. High accuracy and stability make the LI-610 an ideal water vapor source for calibrating the H₂O gas analyzers in the LI-6400XT sensor head.

- NIST (National Institute of Science and Technology) certified
- Generates stable dew points from 0 to 50 °C
- Accuracy of ± 0.2 °C dew point
- Completely portable and self-contained (battery or AC operated)
- No need for gas tanks and mixing systems
- Millivolt output of dew point temperature for data acquisition
- External control via 0-5 V input signal



Light Sources



6400-02B Red/Blue LED Light Source

The 6400-02B is completely integrated with the hardware and software of the LI-6400/6400XT Portable Photosynthesis System, providing maximum ease-of-use and application flexibility. The LED Light Source can produce any light intensity from 0 to 2000 $\mu\text{mol m}^{-2} \text{s}^{-1}$. The use of LEDs with low power consumption makes the 6400-02B a practical light source because of its small size and its ability to operate from the LI-6400XT batteries. LEDs also minimize the influence of the light

source on the leaf environment because they have low heat generation compared to other light sources.

The 6400-02B Light Source red LEDs are used to provide radiant output at 665 nm (nominal), while blue LEDs provide output at 470 nm. The output of the blue LEDs is crucial for studying stomatal kinetics.

The 6400-02B replaces the upper half of the standard leaf chamber, and mates with the standard 2 x 3 cm chamber bottom.



6400-18A RGB Light Source

The 6400-18A is designed to be interfaced with the 6400-17 Whole Plant Arabidopsis Chamber and other specialized chambers, including custom chambers. This 7 cm diameter light source features LEDs with independent control of the intensity and percent of red, green, and blue light. White light can be achieved by using equal proportions of red, green, and blue. Select any intensity of a pre-defined color, or define your own blended color by selecting the proportion of red, green, and/or blue light to be applied to the sample. The

6400-18A can be easily configured to emulate the output of the 6400-02B Red/Blue LED Light Source for comparison studies.

The light source intensity can be changed for light response curves, set to match external PAR sensor readings, or held constant while other environmental conditions are altered. Light and CO₂ response curve AutoPrograms are built into OPEN software that can be used to automatically control and collect data for unattended curves.

The 6400-18A mounts easily to the 6400-17; the propafilm-covered plate used with the Whole Plant Arabidopsis Chamber attaches directly to the Light Source. This method of attachment ensures that the geometry between the plant sample and the light source is repeatable for every measurement.

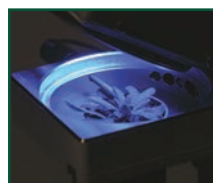

Accessories

6400-70 AC Adapter

Replaces one of the 6400-03 Rechargeable Batteries in the LI-6400XT console to provide for an AC power supply.

6400-19 Custom Chamber Kit

Contains sample cell optical path mounting plate and accessories for mounting custom chambers to the LI-6400XT sensor head.

6400-88 Expanded Temperature Control Kit

For increasing the range of temperature control of the sensor head block.

6400-89 Insect Respiration Kit

The 6400-89 Insect Respiration Kit is for LI-6400XT users interested in measuring the respiration rate of insects, small mammals, small fruits, nuts, etc.

9964-053 Sample Cell Outlet Manifold

The Sample Cell Outlet Manifold replaces the bottom leaf chamber and isolates the sample cell from the leaf chamber so the LI-6400XT can be used as a stand-alone gas analyzer.

9964-098 Leg Extensions

Raises the LI-6400XT console an additional 12 inches. Set of four.

Fluorescence Adapter Chambers

Simultaneous measurements of chlorophyll fluorescence and gas exchange can be made with fluorometer adapter chamber tops, in conjunction with fiber optic probes from other manufacturers. The chamber tops are designed to hold 2 mm, 8 mm, or 10 mm fiber optic probes at a 60° angle from the leaf plane.

Leaf Chamber Fluorometer

Measure Fluorescence and Gas Exchange Simultaneously



The 6400-40 Leaf Chamber Fluorometer attaches to the LI-6400XT sensor head to form an integrated, powerful Portable Fluorescence and Gas Exchange System. Using the 6400-40, you can:

1. Make simultaneous measurements of fluorescence and gas exchange over the same area of the leaf.
2. Combine fluorescence and gas exchange data into a single data set for maximum correlation.
3. Create user-defined manual or automatic measurement protocols.
4. View real-time numeric and graphic data on the LI-6400XT console and/or your computer.

The Leaf Chamber Fluorometer is a pulse-amplitude modulated (PAM) fluorometer that can be used to take measurements on both dark- and light-adapted samples. Measured parameters include F_o , F_m , F , F_m' , and F_o' , and calculated parameters include F_v , F_v/F_m , F_v'/F_m' , Φ_{PSII} , qP , qN , NPQ, and ETR. The 6400-40 provides complete control over the actinic and saturation (independently controlled red 630 nm and blue 470 nm LEDs), measuring (red 630 nm LEDs, modulated from 0.25 to 20 kHz), and far-red (740 nm LED for PSI excitation) light.

The unique design of the 6400-40 Leaf Chamber Fluorometer eliminates the need for fragile, awkward fiber optic light guides. The lightweight design and low power consumption of the 6400-40 make it possible for one person to gather data quickly and easily. Calibration information for the Leaf Chamber Fluorometer is stored onboard, making it easy to move between different LI-6400XT consoles.

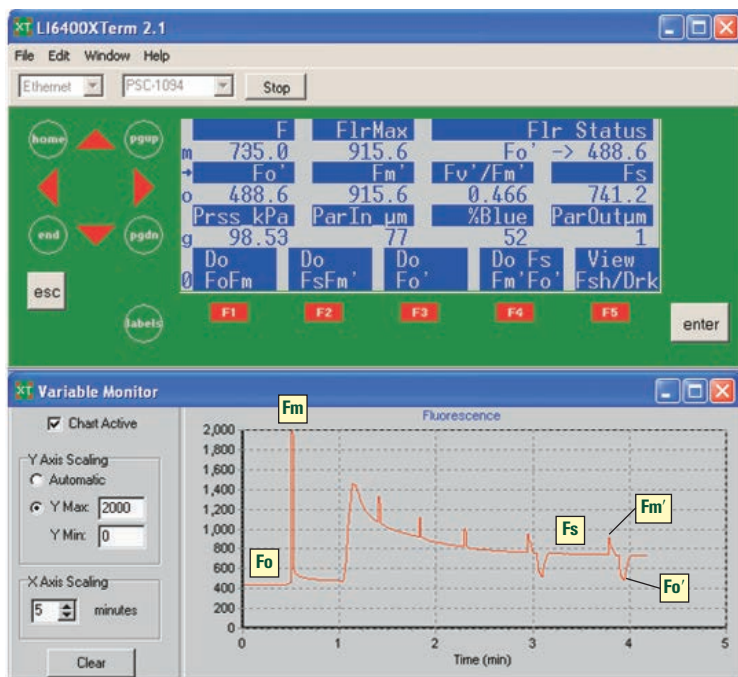

Multiphase Flash™ Fluorescence

F_m' (maximal fluorescence) is usually measured using a single saturating 'multiturnover', or 'rectangular' flash (RF) to reduce the QA-PQ pool. Multiturnover means that the primary acceptor of Photosystem II, QA, is reduced and oxidized multiple times, until the transport chain of QA to PQ is in a reduced state.

In some cases, however, as with high-light adapted field plants, it is difficult to achieve full reduction of the QA-PQ pool with the RF method. Multiphase Flash™ fluorescence, developed by LI-COR scientists, can be used under these conditions to derive true estimates of F_m' , Φ_{PSII} , and ETR within about one second. This is included in the LI-6400XT OPEN software, and can be performed with the Fluorometer. Learn more:

Loriaux, S. D., T. J. Avenson, J. M. Welles, D. K. McDermitt, R. D. Eckles, B. Riensche, and B. Genty. 2013. Closing in on maximum yield of chlorophyll fluorescence using a single multiphase flash of sub-saturating intensity. *Plant, Cell & Environment*. doi: 10.1111/pce.12115

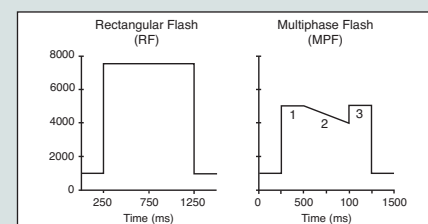

Rectangular flash (RF) method: a saturating multiturnover flash (Q) of 400 to 1200 ms duration. Multiphase flash (MPF) method: (1) high, nearly saturating Q for approximately 250 ms to reduce QA-PQ pool; (2) ramp of declining Q for about 500 ms; (3) return to the initial high Q for approximately 250 ms to check for flash-induced non-photochemical quenching (qN).

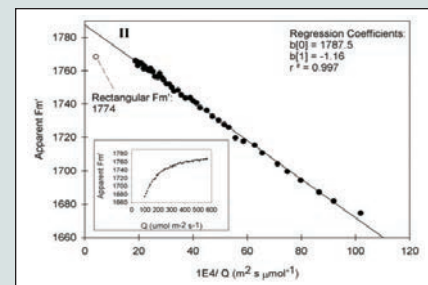

F_m' values from phase 2 of the MPF method are regressed against $1E4/Q$ and extrapolated to estimate the maximal fluorescence at infinite flash intensity.

Ordering Information

LI-6400XT: includes system console; Compact Flash Card, and Ethernet adapter; sensor head with CO₂ /H₂O analyzers; standard 6 cm² leaf chamber with internal PAR sensor; four 6400-03 rechargeable batteries with battery charger; 9-pin to 9-pin RS-232 cable and Serial-USB adapter; LI-6400XT Training DVD; spares kit; carrying case.

Special Pricing Packages

LI-6400XTR

Includes LI-6400XT Portable Photosynthesis System, 6400-40 Leaf Chamber Fluorometer, 6400-01 CO₂ Injector System, 6400-02B Red/Blue LED Light Source, and External Quantum Sensor.

LI-6400XTF

Includes LI-6400XT Portable Photosynthesis System, 6400-40 Leaf Chamber Fluorometer, 6400-01 CO₂ Injector System, and External Quantum Sensor.

LI-6400XTP

Includes LI-6400XT Portable Photosynthesis System, 6400-01 CO₂ Injector System, 6400-02B Red/Blue LED Light Source, and External Quantum Sensor.

LI-6400XTQ

Includes LI-6400XT Portable Photosynthesis System, 6400-01 CO₂ Injector System, and External Quantum Sensor.

LI-6400XTA

Available in North America only. Includes LI-6400XT Portable Photosynthesis System, 6400-01 CO₂ Injector System, External Quantum Sensor, 6400-17 Whole Plant Arabidopsis Chamber, 6400-18A RGB Light Source, and 6400-70 AC power supply.

LI-6400XTE

Available in North America only. Includes LI-6400XT Portable Photosynthesis System, 6400-40 Leaf Chamber Fluorometer, 6400-01 CO₂ Injector System, 6400-02B Red/Blue LED Light Source, External Quantum Sensor, 6400-09 Soil CO₂ Flux Chamber, 6400-89 Insect Respiration Kit, 6400-88 Expanded Temperature Control Kit, 6400-70 AC Power Supply, 6400R-785 Two-Year Extended Warranty, and 6400-520 Photosynthesis Educational Resource package.

6400-40DBX

Includes 6400-40 Leaf Chamber Fluorometer (with spares kit and instruction manual) and the 6400-926 XT upgrade with OPEN 6.X software.

Upgrading Older LI-6400s

To protect your investment, LI-COR has made every effort to ensure that your LI-6400 can be upgraded to the current LI-6400XT configuration. An upgrade package (p/n 6400-926) consists of a new digital board and instrument case that provides the access door for the compact flash/Ethernet expansion slot. The upgrade kit can be user or factory installed, and includes the latest instrument software, compact flash card, Ethernet adapter and cable, and instruction manuals.

LI-COR® Biosciences

Global Headquarters

4647 Superior Street • Lincoln, Nebraska 68504
Phone: +1-402-467-3576 • Toll free: 800-447-3576 • Fax: +1-402-467-2819
envsales@licor.com • envsupport@licor.com • www.licor.com/env

Regional Offices

LI-COR GmbH, Germany

Serving Andorra, Albania, Belarus, Cyprus, Estonia, Germany, Iceland, Latvia, Lithuania, Liechtenstein, Malta, Moldova, Monaco, San Marino, Ukraine, and Vatican City.

LI-COR Biosciences GmbH • Siemensstraße 25A • 61352 Bad Homburg • Germany
Phone: +49 (0) 6172 17 17 771 • Fax: +49 (0) 6172 17 17 799
envsales-gmbh@licor.com • envsupport-gmbh@licor.com

LI-COR Ltd., United Kingdom

Serving Denmark, Finland, Ireland, Norway, Sweden, and UK.

LI-COR Biosciences UK Ltd. • St. John's Innovation Centre • Cowley Road • Cambridge • CB4 0WS • United Kingdom
Phone: +44 (0) 1223 422102 • Fax: +44 (0) 1223 422105
envsales-UK@licor.com • envsupport-UK@licor.com

LI-COR Distributor Network: www.licor.com/env/distributors

LI-6400XT Specifications*

CO₂ Analyzer

Type: Absolute, open path, non-dispersive infrared gas analyzer

Range: 0-3100 μmol mol⁻¹

Bandwidth: 10 Hz

Signal Noise (Precision):

Within 0.2 μmol mol⁻¹ RMS at 1 Hz with 4 second averaging at 400 μmol mol⁻¹

1-Second signal averaging at 350 μmol mol⁻¹

RMS: 0.07 μmol mol⁻¹

Peak-to-peak: 0.3 μmol mol⁻¹/0.8 μmol mol⁻¹ maximum

4-Second signal averaging

RMS: 0.04 μmol mol⁻¹

Peak-to-peak: 0.2 μmol mol⁻¹

Accuracy: Maximum deviation: ± 5 μmol mol⁻¹ from 0 to

1500 μmol mol⁻¹ ± 10 μmol mol⁻¹ from 1500 to 3100 μmol mol⁻¹

Sensor: Solid state. Minimal sensitivity to motion

Orientation Sensitivity: ≤ ± 1 μmol mol⁻¹ at 350 μmol mol⁻¹ from any orientation.

H₂O Analyzer

Type: Absolute, open path, non-dispersive infrared gas analyzer

Range: 0-75 mmol mol⁻¹, or 40 °C dew point.

Bandwidth: 10 Hz.

Signal Noise (Precision):

1-Second signal averaging at 20 mmol mol⁻¹

RMS: 0.009 mmol mol⁻¹

Peak-to-peak: 0.04 mmol mol⁻¹/0.06 mmol mol⁻¹ maximum

4-Second signal averaging

RMS: 0.007 mmol mol⁻¹

Peak-to-peak: 0.03 mmol mol⁻¹

Accuracy: Maximum deviation: ± 1.0 mmol mol⁻¹ from 0-75 mmol mol⁻¹

Temperature

Operating Temperature Range: 0 °C to 50 °C

Optical Housing Block and Air Temperature:

Sensor Type: 3-wire thermistor

Range: -10 to 50 °C

Accuracy: Maximum error < ± 0.5 °C

Typical Error: < ± 0.25 °C

Temperature Control: Leaf chamber can be heated or cooled ± 6 °C from ambient

Control Range: 0 to 50.0 °C

Set point Resolution: 0.2 °C

Leaf Temperature Thermocouple:

Type: E

Range: ± 50 °C of reference

Reference: Optical housing block thermistor

Accuracy: ± 10% of T difference between sample and reference junctions with amplifier zeroed; typically < 0.2 °C

Air Flow

Flow rate: 0 to 700 μmol s⁻¹

Pressure

Pressure Range: 65 to 115 kPa absolute

Accuracy: ± 0.1% of full scale

Resolution: 0.002 kPa

Signal Noise (peak-to-peak): 0.002 kPa typical

System Console

Processor: 400 MHz Intel XScale

Memory: 128 MB RAM for operation; 64 MB flash memory for data storage.

Display: Adjustable contrast, backlight, 8 line × 40-character (240 × 64-dot) LCD graphic display

Keyboard: Full ASCII keypad, sealed from dust and moisture with membrane overlay

Power Requirement: 10.5 to 15 VDC; 4A maximum (current draw dependent upon system operation). < 10A momentary peak

Output

RS-232: Hardwired DTE. RS-232 to USB adapter included

Format: User-definable ASCII

Expansion Slot: Supports either Compact Flash or Ethernet card adapter

Compact Flash Card: Industrial Grade (included)

Ethernet Card Adapter: Type 1 CF Ethernet card, 10/100 Mbps (included)

6400-01 CO₂ Injector

CO₂ Mixing Range: < 50 μmol mol⁻¹ to > 2000 μmol mol⁻¹

Operating Temperature Range: 0-50 °C

CO₂ Source Assembly:

Type: 12g pure liquid CO₂ cylinder

Lifetime: 8 hours after activation, regardless of use

CO₂ Tank Connector Block:

Minimum Pressure: 1250 kPa (180 psig)

Maximum Pressure: 1500 kPa (220 psig)

Usage Rate: constant at ≈10 sccm

Light Measurement

PAR Internal and External Chamber Sensors:

Range: 0 to > 3000 μmol m⁻² s⁻¹.

Resolution: < 1 μmol m⁻² s⁻¹.

Calibration Accuracy: ± 5% of reading, traceable to NIST.

Spare I/O Channels

Input Channel: five differential analog, two digital, and one pulse counting

Digital Outputs: 8 open drain

Analog Outputs: 7 D/A 8-bit, 1 D/A 12-bit, uncalibrated CO₂ and H₂O reference and sample analyzer outputs, +5V regulated power supply (100 ma), battery voltage (fused, 200 ma)

*Specifications subject to change without notice.

The LI-COR board of directors would like to take this opportunity to return thanks to God for His merciful providence in allowing LI-COR to develop and commercialize products, through the collective effort of dedicated employees, that enable the examination of the wonders of His works.

“Trust in the LORD with all your heart and do not lean on your own understanding. In all your ways acknowledge Him, and He will make your paths straight.”

—Proverbs 3:5,6

LI-COR is a registered trademark of LI-COR, Inc. All brand and product names are trademarks or registered trademarks of their respective owners. For patent information, visit www.licor.com/patents © 2015, LI-COR Inc. Printed in the U.S.A.

LI-COR®